



SPOTLIGHT
HORSE SHOWS

2024 US National Dressage Classic Qualifying Show

Dallas Dressage Club

DDC Summer Virtual Show

DDC Year End Award Program

US National Dressage Classic
Online Regional Qualifier

WDAA, FHANA, APHA-PAC
Recognized



Western Dressage, Dressage, Driven Dressage Online Show



Entries Open Dates: July 5 - 28, 2024

Video Submission: through August 18

Results by: August 29

Enter at: [SpotlightHorseShows.com](https://www.spotlighthorseshows.com)



ONLINE COMPETITION SERIES

- WDAA Recognized: #24-282
- Qualifier for WDAA World Show & USNDC Regionals
- DDC Year End Awards Program

DRESSAGE | WESTERN DRESSAGE | DRIVEN DRESSAGE

Our Judges

Dressage & Eventing Dressage: Ida Norris - S
Western Dressage: Ida Norris - R
Driven Dressage: Marcie Quist - S

Additional judges may be added as needed

Show Secretary

Gail Matheus

For show specific questions, contact Gail at Gail@SpotlightHorseShows.com

Quick Links

Click on the Topic to Jump to that Page

Arena Sizes

[Ridden Dressage Arenas](#)

[Driven Dressage Arenas](#)

[Sport Horse In-Hand](#)

Awards

[Show Awards](#)

[American Paint Horse – PAC Program](#)

[Friesian Horse Association of North America – Performance and Predicate Program](#)

[WDAAZ Awards Program](#)

[US National Dressage Classic](#)

[Western Dressage Association of America Program](#)

Class Lists by Division

[Dressage](#)

[Driven Dressage](#)

[Eventing Dressage](#)

[Western Dressage](#)

How to Enter

[Fees & Refunds](#)

[Rider Status](#)

[Using the Website](#)

Competition Guidelines

[Minor Athlete Abuse Prevention \(MAAP\)](#)

[Video and Equipment Rules](#)

[General Western Dressage Rules](#)

[Guidelines for Gaited Horses](#)

Donations & Sponsorships

[Community Outreach Programs](#)



Awards & Eligibility

**RIBBONS – Will be awarded through 6th place.
Ties will not be broken.**



Dallas Dressage Club End of Year Awards (membership required)

- VISIT DDC FOR QUESTIONS AND MORE INFORMATION.

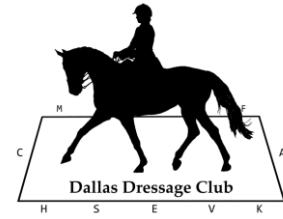

US NATIONAL DRESSAGE CLASSIC REGIONAL QUALIFIER

Riders are eligible to compete in the Regional Championship for their home state. See these pages for full details.

[Regions & Dates](#)

[Qualifying Scores](#)



WDAA HORSE LIFETIME POINTS AND AWARDS PROGRAM

Scores earned at this show count ½ points toward WDAA Horse Lifetime Points & Awards Program. It is optional to participate in this program. For more information, or to enroll in the program, please visit [WDAA Horse Lifetime Points](#)

2024 WDAA WORLD QUALIFIER

Please refer to the [Western Dressage Association of America's World Show Website](#) for details.

The World Show will be held at the Lazy E Arena in Guthrie, OK

Dates: September 18-22, 2024

Qualification Requirements

- The horse qualifies and must qualify for every level that it will show in the World Show.
- For Introductory – Basic levels, the horse must earn 63% or higher, in at least 1 WDAA Recognized show, either in person or online.
- For Level 1-5 the horse must earn 60% or higher, in at least 1 WDAA Recognized show, either in person or online.
- The qualification period begins October 1st, 2023, and ends August 26th, 2024.
- If the horse has qualified in the appropriate levels by the requirements above, there is no need to qualify for rail classes or freestyle with a score.

RECOGNITION – refer to their websites for details



APHA-PAC



WDAA



Friesian Horse Assoc. of N.A.



American Warmblood Society

How To Enter

Step 1: Complete Your Entry Information

- Create an account or log-in at www.spotlighthorsheshows.com
- Go to "Select A Show" from the drop down menu.
- Enter the show office information first – Add to cart to complete form. Note: You will need your membership numbers. Close window.
- Click on "Select Your Classes". Select the division(s) your are showing in. (Dressage, Eventing Dressage, Western Dressage, Driven Dressage). Hint: Filter on your competition level
- Add to cart classes to your shopping cart & check out

b Select a Show Submit Video Links Success Stories Gift Cards **a** Login **e**

US NATIONAL Dressage Classic

This show is open to all riders. The only classes which are restricted are the regional championship classes.

Entries Open: July 22 – August 11, 2022
Video Submission: through September 9, 2022
Judging Period: September 10 – 19, 2022
Judges will be assigned based on the home region of the rider. The full list of judges are in the prize list below.
HOW DO I GET QUALIFIED? [CLICK HERE](#) for more information.

WDAA World Championship Show Qualifier
WDAA Recognition # TBD

USNDC Regional Finals
Two Champions per level will be pinned in each region, division, and level.
The All-Around Champion is the team with the best average score for competing in all the tests of the level.
The Level Champion is the team with the best score at the highest test of the level.
Qualify by showing in Spotlight Horse Show prior events from August 15, 2021 through August 15, 2022.
Horse and rider qualify for the classes where they earned the score.
The National Finals which will be held in November, 2022.

APHA PAC and OHS A Approved

[Prize List](#)

c SHOW OFFICE INFORMATION: Add to cart, then select classes below.

d SELECT CLASSES: Filter on your division and levels to see classes

d **FIRST, SELECT YOUR DIVISION**

DRIVEN DRESSAGE DRESSAGE WESTERN DRESSAGE EVENTING DRESSAGE

All /



d **DRESSAGE DIVISION**

Junior Amateur Open Freestyle

How To Enter

Step 2: Membership and Competition Level Verification

- Your class selection will be verified prior to confirmation of your show entry.
- Upon acceptance, you will receive an e-mail with your pre-filled class sign. This must be displayed at the start of your video

		Entry # 100
Show Name: DDC Summer Virtual Show		
Rider: Jane Smith		
Horse: Ima Winner		
Class Number: PSG: Prix St. George		
Video Date: _____		
<small><u>Instructions:</u> Fill in the video date. Film in landscape position only. Continuously film and keep the rider/horse in frame through the end of the equipment check.</small>		

Step 3: Film and Upload Your Videos

- Read the video rules that come with your video sign package and follow them carefully
- If you do not already have one, create your YouTube channel and upload your videos.
- Once done, copy and paste the class description and video links on the [Video Submission Form](#) found on the show website.

Step 4: Judging and Results

- Your classes will be judged within 10 days after the video submission phase ends.
- All judge's decisions are final.
- Results will be posted the day following the judging period at the show website.
- Copies of your completed test sheets will be e-mailed to you.

Note:

- Management reserves the right to change officials, combine or cancel classes, and modify the schedule to make whatever changes are required by circumstances to the competition specifications.
- Management reserves the right to refuse or require withdrawal of an entry for cause deemed sufficient by Show Management. and add to cart

2024

US NATIONAL DRESSAGE CLASSIC

REGIONAL CHAMPIONSHIP QUALIFIER

2 Championship Levels

Qualifying Period: August 16, 2023 – August 22, 2024

Regional Championships: Opens 7/28 Closes 8/25. Videos through 9/15

National Finals: Opens 9/27 – 10/20. Videos through 11/10

GROUP QUALIFIERS

- Enter any Spotlight Dressage show designated as a qualifier
- Riders who score a minimum of 60% at the highest test of the level are automatically qualified for the **Level Championship** at the on-line regional championships.
- Enter all classes of the level in the same show to be eligible for the **All-Around Championship** for that level. Average score must be a minimum of 60% to advance.

REGIONAL CHAMPIONSHIPS

- There are 7 regions
- Riders with the minimum scores of 60% advance to the National Finals for both the Level and All-Around Championships.

Riders can participate in any show qualifier nationwide but will represent their home state in the Regional Championships

QUALIFIED DRIVEN DRESSAGE DRIVERS GO STRAIGHT TO THE NATIONALS!

NATIONAL FINALS

- Two Champions per Level
 - All-Around Champion
 - Level Champion

SPOTLIGHT HORSE SHOWS REGIONAL MAP

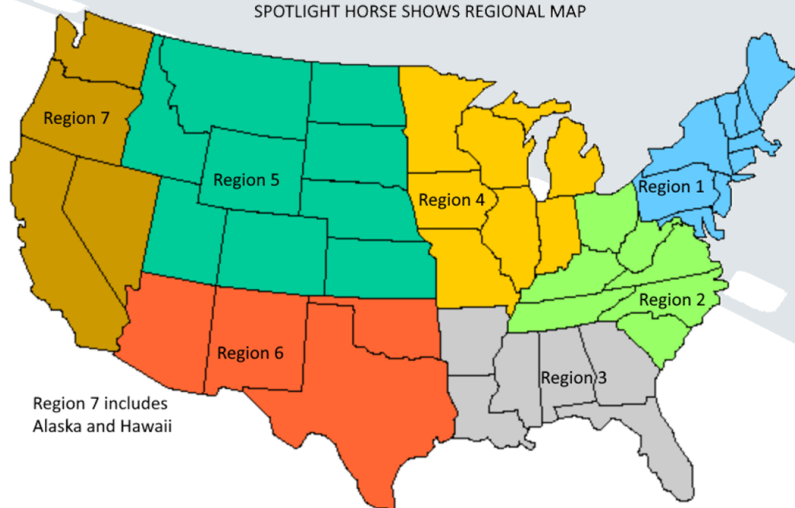

HOW TO ADVANCE TO THE FINALS

Level Champion

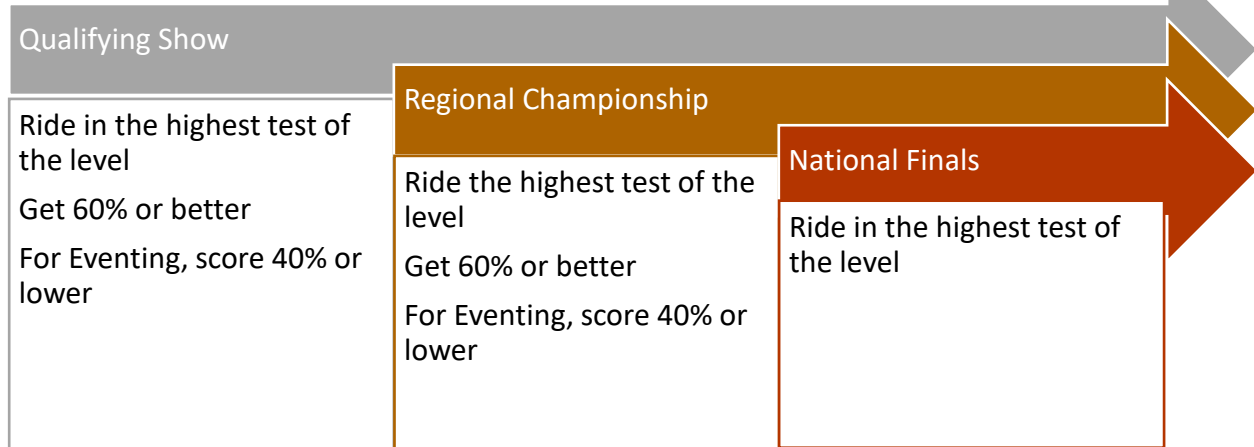

All-Around Champion

US National Dressage Classic - Roadmap
Spotlight Horse Shows

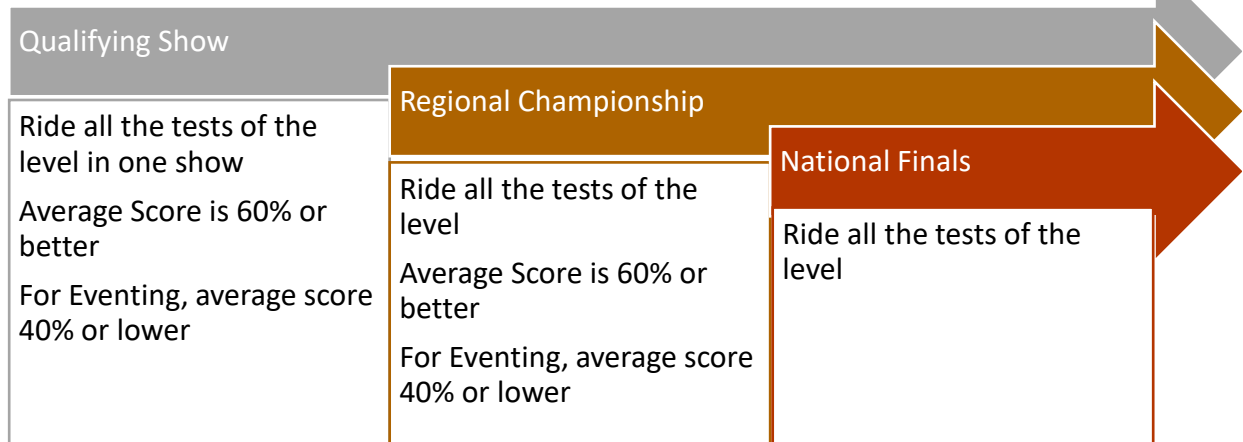

Awards:

Buckles, Plaques, Medallions, Ribbons & More!

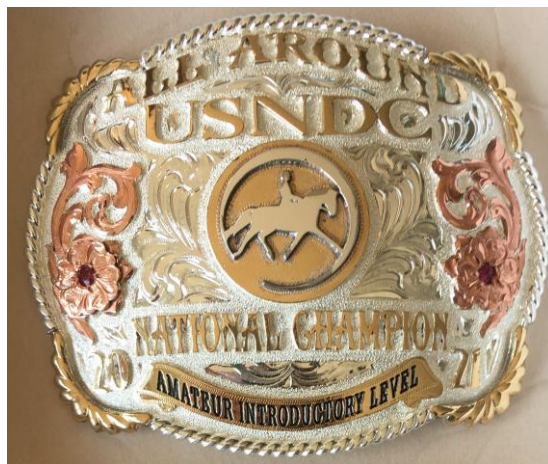

Fees and Refunds

DRESSAGE DIVISION FEES	
Introductory – Fourth Level	\$37
Prix St. Georges – Grand Prix	\$40
Musical Freestyle	\$40

EVENTING DIVISION FEES	
All Classes	\$37

WESTERN DRESSAGE DIVISION FEES	
Introductory - Level 5	\$37
Musical Freestyle	\$40

DRIVEN DRESSAGE DIVISION FEES	
All Classes	\$50

ADMINISTRATIVE FEES	
Show Office Fee	\$30
Horse/Rider/Class Change Fee Use this form.	\$25
Late Entry Fee Use this form.	\$25
Insufficient Funds	\$25

- Payment: Entries must be completed online at SpotlightHorseShows.com with online entry form by the closing date.
- Payment is accepted through PayPal or credit card. All fees are in US dollars.
- One show office entry fees allows the same horse and rider team to cross-enter divisions.
- Horse, rider, or class changes after the closing date are subject to a \$25 change fee.
- Late entries are subject to a \$25 late entry fee.
- Refunds: Entries canceled for any reason prior to the closing date will be refunded, minus the show office fee. There are no refunds after the closing date. In the event the competition is canceled, Total Entry Fees minus the office fee will be refunded. Thank you for understanding.

Video Rules

You may videotape your ride/drive as soon as you have your sign. Videos must be in focus. Remember, the judge can only score what they can see, so follow these guidelines carefully! Please refer to the [MAAP](#) information.

IMPORTANT! Show Management will review all submissions to ensure adherence to the rules as stated below. If a test does not comply with the rules, Show Management will contact the exhibitor immediately via email, text, or phone. The exhibitor will have 48 hours to resubmit their test from the time of the notification. Please take all guidelines into consideration when preparing your test submissions.

Applies to all Divisions:

- Use arenas that are as close to regulation size as possible and be sure letters are set appropriately to be viewed by the judge. Cones with large letters on them and poles on the ground to delineate the corners are acceptable. Large letters taped on walls work as well. If a test allows for the use of either the large or small arena, you can show in either size.
 - To ensure that only videos taped for this competition are used, videos of tests must be unedited from start to finish, including the sign and equipment check and bridle/bit drop. They must be one continuous recording with the horse and rider visible at all times. Bridle and saddle pad numbers are not allowed.
 - Videos must be filmed in LANDSCAPE orientation.
 - The natural background sound for the test must be audible. Tests with no sound will not be accepted.
 - Only video links from YouTube will be accepted.
 - The test must be videoed from behind C, where the judge would normally be seated. Try and set the camera 4-5' off the ground. It makes the geometry easier for the judge to see.
 - Prior to beginning the test, a sign must be held up showing the show name, WDAA show recognition number (if applicable), date of the show, horse name, & riders/driver name, class # and test. Remove the sign just before the ride begins. The videographer can hold the sign then move back to behind the camera or hold the sign in front of the camera at arm's length while also holding the camera. There must be no edits between when the sign is shown and the rider/driver appears.
 - Keep the horse & carriage in frame, paying close attention to the near corners. On the far side, you will need to zoom in for clearer judging visibility. For ridden dressage, the horse and rider must be visible at all times through to the end of the equipment check. For driven dressage, the horse and driver must be visible at all times through to the exit of the arena.
 - Make sure to keep the letters in the frame that are elements of the test being performed.
-

Division Specific Information:

- Dressage & Western Dressage Equipment Check: As soon as the test is finished, the camera must slowly circle the horse and rider showing all equipment and attire, including spurs and whip if used. If the videographer is unable to enter the arena, at G the rider may turn the horse slowly, wait five seconds, then turn slowly to show the second side, and wait an additional 5 seconds to complete filming of the equipment. Show the entire horse, including the legs and feet. Zoom in for 3 seconds so the details of the spurs are visible. The rider then dismounts and shows that 2 fingers will fit under the cavesson (noseband) or bosal by the side of the horse's check. Standard Equipment Rules apply to all divisions.
- ADDITIONAL Requirements for Western Division Only: After putting 2 fingers under the cavesson or bosal the bridle and bit /bosal must be dropped so it can be evaluated. **Exceptional riders** are exempt from the bridle and bit/bosal dropping requirement and are not required to dismount.
 - Hold the bridle still so the bit can clearly be seen (in focus and in frame) for a minimum count of five seconds. Zoom in so details can easily be seen. Make sure the judge can see all parts of the bridle, including bit and reins clearly. Do not obscure the bit, curb strap, curb chain.
 - A cavesson (noseband) must be shown to the camera, both inside and out. Demonstrate flexibility of the cavesson.
 - Demonstrate that the curb strap or chain is flexible and is at least ½ inch wide.
 - Bosal: If you are using a bosal, you must drop that as well. After you remove the bosal, show both sides of your horse's face, unobstructed, as well as the bosal. Demonstrate flexibility of the bosal.
- Driven Dressage: It is highly recommended that you mark X (a small pile of shavings works well) so the judge can see it.
- Apparel & Equipment Rules: Standard equipment rules for the division ridden must be used. ADS/FEI rules apply to Driven Dressage. USEF equipment and apparel rules apply to the Western Dressage division. Clean, neat, and tidy schooling show dress for qualifier shows is allowed for dressage, but show clothes are required for USNDC Regional and National Competitions.
- Calling of Tests: The test pattern may be called (with the exception of driven dressage and freestyles), but Coaching during the test is not allowed EXCEPT for WDAA Exceptional Rider tests.

Arena Sizes for Ridden Dressage

For tests allowing for either size arena, you may use either one. Be aware that some test call for only 1 size arena. In those cases, you must use that. Below are the dimensions needed for you to set up your arena at home.

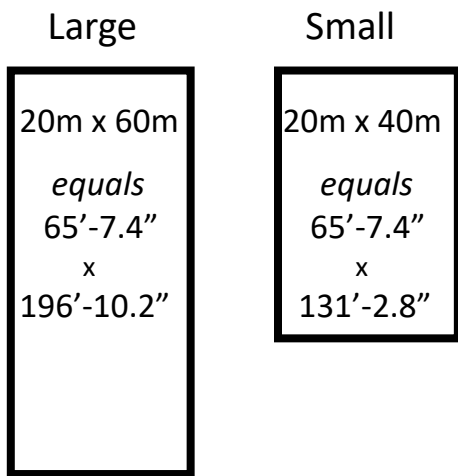
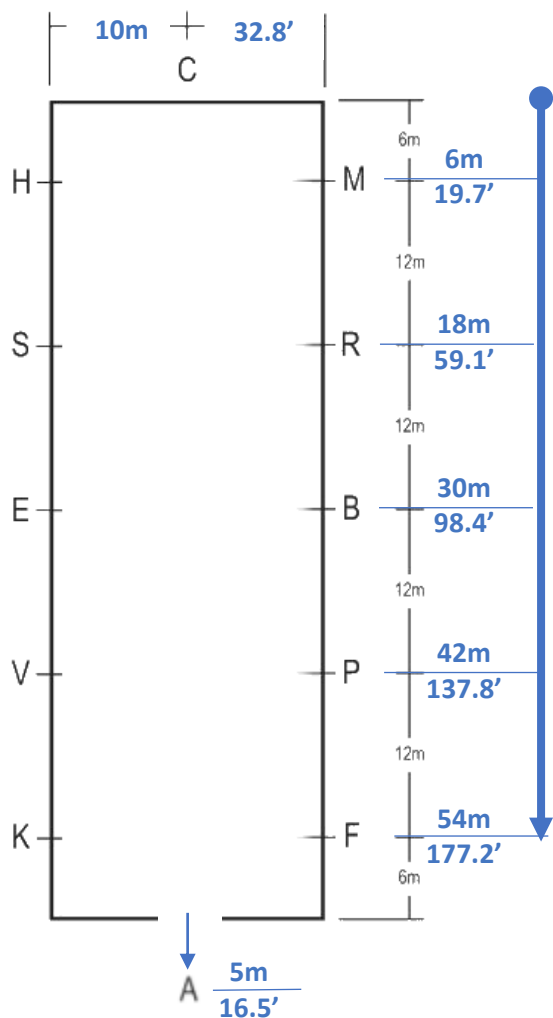

In the LARGE arena:

- Place a mark on the long rail at the following distances from the corner:
 - M: 6m = 19.7'
 - R: 18m = 59.1'
 - B: 30m = 98.4'
 - P: 42m = 137.8'
 - F: 54m = 177.2'
- Place your letters 2 feet from the rail as these marks
- Repeat on the other long side

In the SMALL arena:

- Place a mark on the long rail at the following distances from the corner:
 - M: 6m = 19.7'
 - B: 20m = 65.6'
 - F: 34m = 111.5'
- Place your letters 2 feet from the rail as these marks
- Repeat on the other long side
- C is 10m (or 32.8') in on the short side. Place that letter 2' from the rail as well.

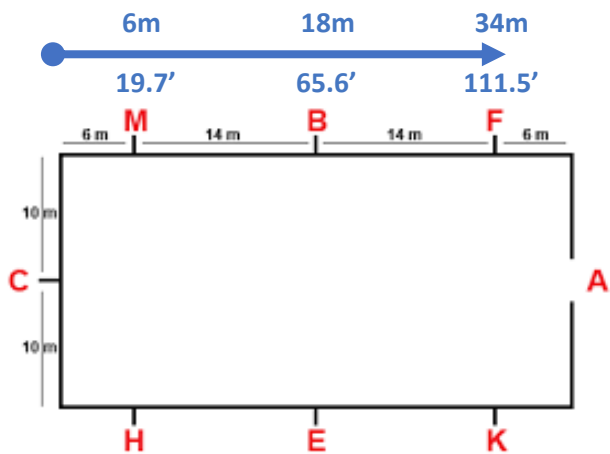

Sport Horse In-Hand Triangle Set-up & Video Rules

Horses will stand in the "open position" for conformation judge both BEFORE and AFTER the walk and trot around the triangle. The entire horse must be in-frame at all times.

Conformation View #1

Before the walk, show the left side of the horse for at least 10 seconds.

Movement Evaluation

Horses will travel to the right (clockwise) around the triangle two (2) times. Be sure to travel on the outside of the cones.

The first circuit will be at the walk and the second time at the trot.

Dependent upon the space available, you have 2 options in which to set up the triangle.

Diagrams and dimensions are picture below.

Conformation View #2

After the trot, show the right side of the horse, plus a view from the back and the front.

The camera can be moved to get the front and back views OR you can reposition the horse.

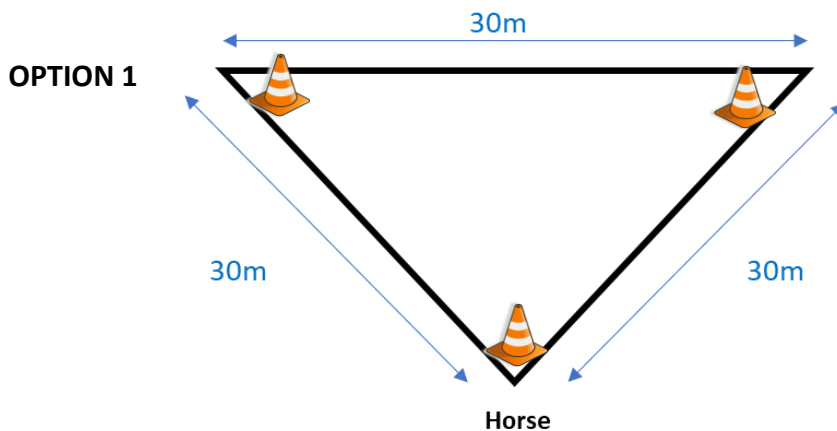

Camera Position

- Place a cone in each corner
- Horse travels clockwise around the outside of the cones.

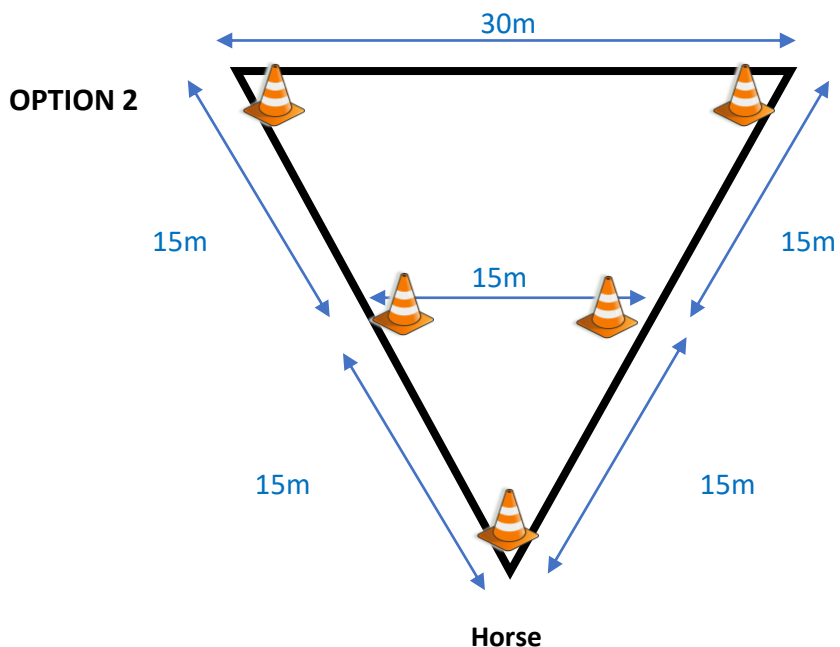

Camera Position

- Place a cone in each corner and midway along each of the left and right sides.
- Horse travels at a walk clockwise around the outside of the cones marking the small 15m triangle.
- Horse then travels at a trot (clockwise) around the outside of the larger triangle.



Setting Up Your DRIVEN Dressage Ring

2-3 people make set-up faster and easier.

Print this guide and take it with you during set-up.

1. Determine where you ring will be placed.

The area should be as flat as possible. If desired, allow additional room to drive around the outside of the ring and for placement of the letters.

2. Gather your tools.

You will need the following:

- Stakes (4)
- Hammer (1)
- Masonry Line (400' for the small ring or 500' for the large ring)
- Tape Measure (min 10' with wide blade)
- Permanent Marker
- Long Tape Measure (300' for the small ring or 350' for the large ring)
- Electrical Tape (optional rail marker)

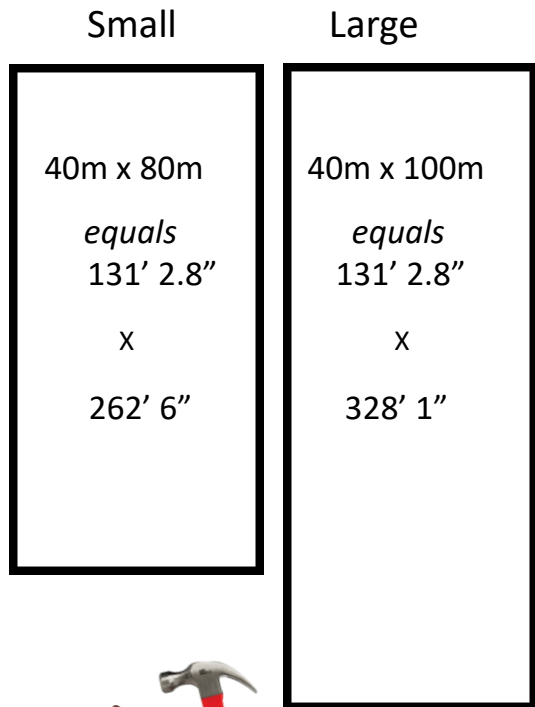

3. Set Your Corners and Rails

- Locate the position of one corner and drive a stake.
- Set the rails using the Pythagorean Theory.
- Mark 1 rail at 6', Mark the 2nd rail at 8'.
- Move the end of the rails until the diagonal line created by the marks equals 10'.

4. Stretch the masonry lines

- Place one along each of the long and short sides and secure to a stake. Place the stakes at the appropriate length of width of the ring you are building.
- Place your rails along these lines.

5. Set Your Next Corner and Rails

- Repeat step 3 & 4 for each of the next corners and sides.

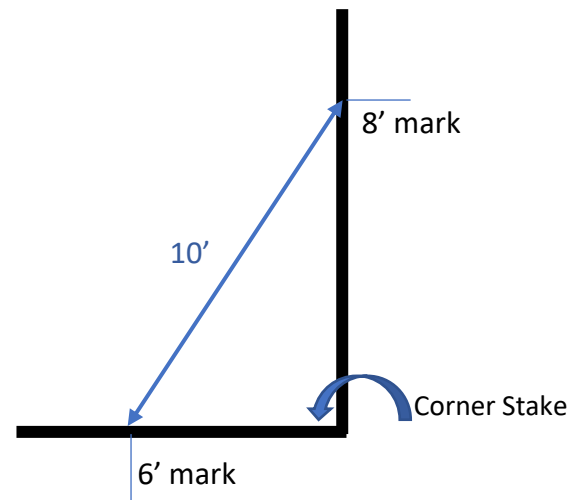

Place The Letters

6a. In the SMALL ring:

- Place a mark on the long rail at the following distances from the corner:
 - M: 10m = 32' 10"
 - B: 40m = 131' 3"
 - F: 70m = 229' 8"
- Place your letters 2 feet from the rail at these marks
- Repeat on the other long side
- C is 20m (or 65' 7") in on the short side. Place that letter 2' from the rail as well.
- A is also 20m (or 65' 7") in on the short side. Place that letter away from the opening

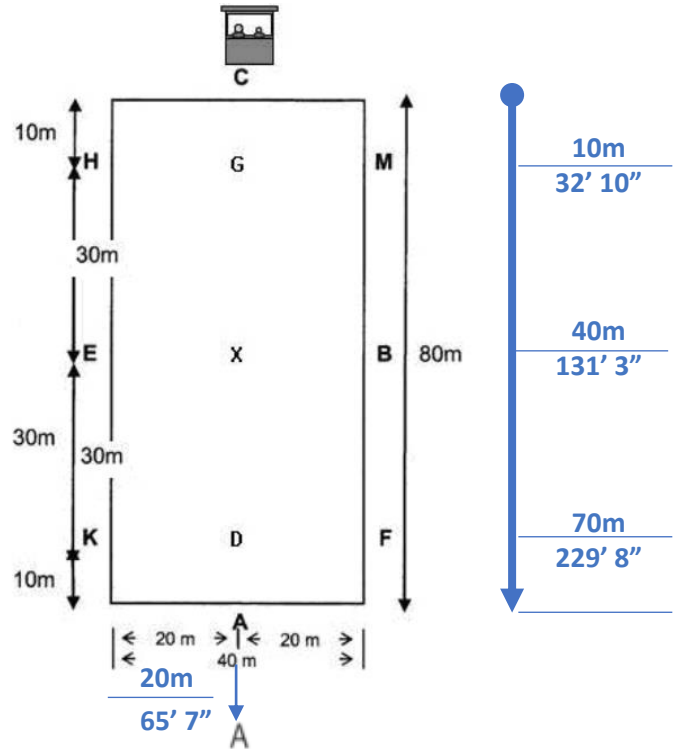

6b. In the LARGE ring:

- Place a mark on the long rail at the following distances from the corner:
 - M: 10m = 32' 10"
 - R: 30m = 98' 5"
 - B: 50m = 164' 1"
 - P: 70m = 229' 8"
 - F: 90m = 295' 3"
- Place your letters 2 feet from the rail as these marks
- Repeat on the other long side
- C is 20m (or 65' 7") in on the short side. Place that letter 2' from the rail as well.
- A is also 20m (or 65' 7") in on the short side. Place that letter away from the opening

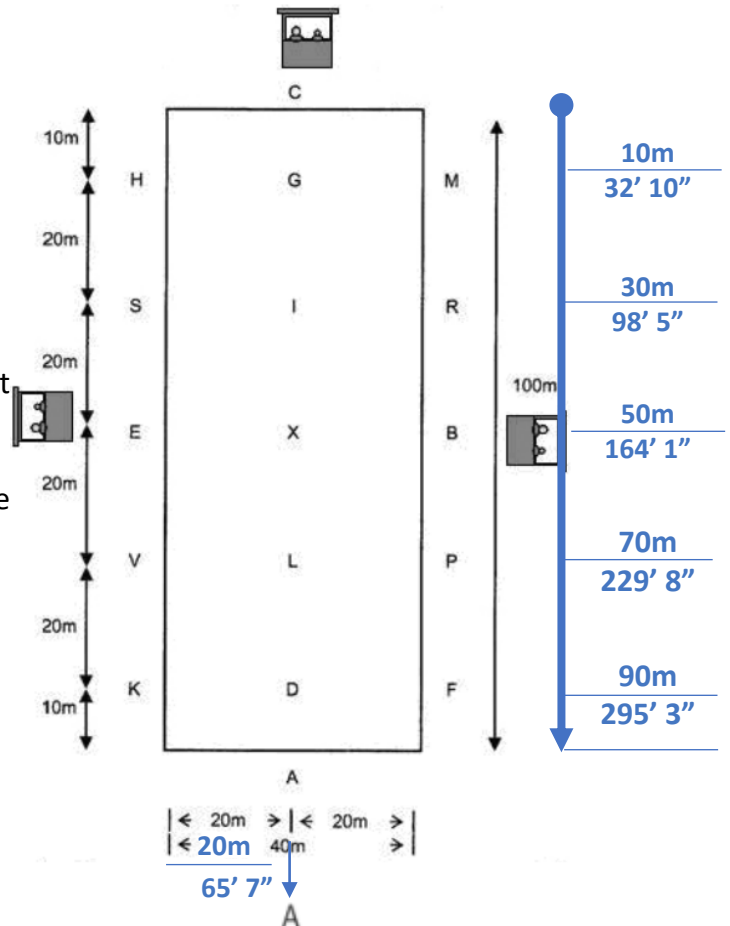

7. HINT: Mark the Rails (Optional):

Mark the letter points on the rails with a contrasting color of tape for more precision riding.

Amateur Status Declaration

To compete in Amateur classes in the Western Dressage Division, competitors are required to provide proof of Amateur status in one of three ways. Declaration can be made at www.spotlighthorsheshows.com

1. Submit a copy of amateur card from a recognized equestrian sports governing organization (USEF, AQHA, APHA etc.)

2. Attest that you are serving an internship for college credit through your respective accredited college program and have never held professional status.

3. Attest that you meet the qualifications below.

I attest that, after my 18th birthday, I have not:

- a) Accepted remuneration for riding, driving, showing, training, schooling, or conducting clinics or seminars.
- b) Accepted remuneration for giving riding or driving lessons, lessons in showmanship, instructions in equitation or horse training. (Persons acting as counselors at summer camps, who are not hired in the exclusive capacity of riding instructors, are excluded and persons giving instructions and training to the handicapped are also excluded).
- c) Accepted remuneration AND acted as an agent in the sale of a horse or pony or accepted a horse or pony on consignment for the purpose of sale or training that is not owned by me, my cohabitant, or family member, a farm/ranch/syndicate/partnership/corporation/business I, my cohabitant or family member controls.
- d) Accepted remuneration for the use of my name, photograph or other form of personal association as a horseman in connection with any advertisement or article to be sold.
- e) Accepted prize money in equitation or showmanship classes, except in amateur or owner classes.
- f) Advertised my professional services such as training or giving lessons by way of business cards, print ads, or internet. Exception: The writing of books or articles pertaining to horses.
- g) Accepted a token of appreciation, other than money, for riding, driving, or showing in hand in halter (tokens worth more than \$300 are considered remunerations)

Junior Status

Riders are eligible to compete as juniors if they are 17 years of age or less at the beginning of the 2022 competition year (December 1, 2021 – November 30, 2022).

Open Classes

Any horse or rider may enter an open class if a junior or Amateur class is not available for that test. Example: Musical Freestyles are Open classes where Juniors, Amateurs, and Professionals compete together.

Any rider with a Professional rating may not enter Junior or Amateur classes.

DRESSAGE DIVISION

CLASS LIST

Qualifier for:

US National Dressage Classic Regional Championships



Enter all tests of the level to be eligible for the All-Around Championship

Description	Open	Amateur	JR
Introductory Level, Test A	IA-O	IA-A	IA-J
Introductory Level, Test B	IB-O	IB-A	IB-J
Introductory Level, Test C	IC-O	IC-A	IC-J
Training Level, Test 1	T1-O	T1-A	T1-J
Training Level, Test 2	T2-O	T2-A	T2-J
Training Level, Test 3	T3-O	T3-A	T3-J
1st Level, Test 1	11-O	11-A	11-J
1st Level, Test 2	12-O	12-A	12-J
1st Level, Test 3	13-O	13-A	13-J
2nd Level, Test 1	21-O	21-A	21-J
2nd Level, Test 2	22-O	22-A	22-J
2nd Level, Test 3	23-O	23-A	23-J
3rd Level, Test 1	31-O	31-A	31-J
3rd Level, Test 2	32-O	32-A	32-J
3rd Level, Test 3	33-O	33-A	33-J
4th Level, Test 1	41-O	41-A	41-J
4th Level, Test 2	42-O	42-A	42-J
4th Level, Test 3	43-O	43-A	43-J
Dressage (TOC)	DSG-TOC	Enter as Open	Enter as Open
Freestyle, Training Level	FS-T	Enter as Open	Enter as Open
Freestyle, First Level	FS-1	Enter as Open	Enter as Open
Freestyle, Second Level	FS-2	Enter as Open	Enter as Open
Freestyle, Third Level	FS-3	Enter as Open	Enter as Open
Freestyle, Fourth Level	FS-4	Enter as Open	Enter as Open
Freestyle, FEI (TOC)	FS-FEI	Enter as Open	Enter as Open
Prix St. George	PSG	Enter as Open	Enter as Open
Intermediaire (TOC)	INTER	Enter as Open	Enter as Open
Grand Prix (TOC)	GP	Enter as Open	Enter as Open
FEI (TOC)	FEI-TOC	Enter as Open	Enter as Open
PARA (TOC)	PARA	Enter as Open	Enter as Open
PARA Freestyle	PARA-FS	Enter as Open	Enter as Open
Sport Horse Prospect In-Hand	SHP	Enter as Open	Enter as Open
Developing Horse (TOC)	DH	Enter as Open	Enter as Open
Young Horse (TOC)	YH	Enter as Open	Enter as Open
Dutch Z1 Test 23	Z1-23	Enter as Open	Enter as Open
Dutch Z1 Test 24	Z1-24	Enter as Open	Enter as Open
Dutch Z1 Test 25	Z1-25	Enter as Open	Enter as Open
Dutch Z1 Test 26	Z1-26	Enter as Open	Enter as Open

WESTERN DRESSAGE DIVISION CLASS LIST



Enter all tests of the level to be eligible for the All-Around Championship Qualifier

Description	Open	Amateur	JR	Gaited
Introductory Level, Test 1	INT1-O	INT1-A	INT1-J	INT1-G
Introductory Level, Test 2	INT2-O	INT2-A	INT2-J	INT2-G
Introductory Level, Test 3	INT3-O	INT3-A	INT3-J	INT3-G
Introductory Level, Test 4	INT4-O	INT4-A	INT4-J	INT4-G
Basic Level, Test 1	BT1-O	BT1-A	BT1-J	BT1-G
Basic Level, Test 2	BT2-O	BT2-A	BT2-J	BT2-G
Basic Level, Test 3	BT3-O	BT3-A	BT3-J	BT3-G
Basic Level, Test 4	BT4-O	BT4-A	BT4-J	BT4-G
Level 1, Test 1	L1T1-O	L1T1-A	L1T1-J	L1T1-G
Level 1, Test 2	L1T2-O	L1T2-A	L1T2-J	L1T2-G
Level 1, Test 3	L1T3-O	L1T3-A	L1T3-J	L1T3-G
Level 1, Test 4	L1T4-O	L1T4-A	L1T4-J	L1T4-G
Level 2, Test 1	L2T1-O	L2T1-A	L2T1-J	L2T1-G
Level 2, Test 2	L2T2-O	L2T2-A	L2T2-J	L2T2-G
Level 2, Test 3	L2T3-O	L2T3-A	L2T3-J	L2T3-G
Level 2, Test 4	L2T4-O	L2T4-A	L2T4-J	L2T4-G
Level 3, Test 1	L3T1-O	L3T1-A	L3T1-J	L3T1-G
Level 3, Test 2	L3T2-O	L3T2-A	L3T2-J	L3T2-G
Level 3, Test 3	L3T3-O	L3T3-A	L3T3-J	L3T3-G
Level 3, Test 4	L3T4-O	L3T4-A	L3T4-J	L3T4-G
Level 4, Test 1	L4T1-O	L4T1-A	L4T1-J	L4T1-G
Level 4, Test 2	L4T2-O	L4T2-A	L4T2-J	L4T2-G
Level 4, Test 3	L4T3-O	L4T3-A	L4T3-J	L4T3-G
Level 4, Test 4	L4T4-O	L4T4-A	L4T4-J	L4T4-G
Level 5, Test 1	L5T1-O	L5T1-A	L5T1-J	L5T1-G
Level 5, Test 2	L5T2-O	L5T2-A	L5T2-J	L5T2-G
Level 5, Test 3	L5T3-O	L5T3-A	L5T3-J	L5T3-G
Level 5, Test 4	L5T4-O	L5T4-A	L5T4-J	L5T4-G
Freestyle, Intro Level	WDFS-IN	Enter as Open	Enter as Open	Enter as Open
Freestyle, Basic Level	WDFS-B	Enter as Open	Enter as Open	Enter as Open
Freestyle, Level 1	WDFS-1	Enter as Open	Enter as Open	Enter as Open
Freestyle, Level 2	WDFS-2	Enter as Open	Enter as Open	Enter as Open
Freestyle, Level 3	WDFS-3	Enter as Open	Enter as Open	Enter as Open
Freestyle, Level 4	WDFS-4	Enter as Open	Enter as Open	Enter as Open
Freestyle, Level 5	WDFS-5	Enter as Open	Enter as Open	Enter as Open
CFS-I5: Costume Freestyle Level of Choice	CFS-I5	Enter as Open	Enter as Open	Enter as Open
Test of Choice	WD-TOC	Enter as Open	Enter as Open	Enter as Open
Horsemanship, Walk-Jog - Pattern B	HWJ	Enter as Open	Enter as Open	Enter as Open
Horsemanship, Intermediate - Pattern B	HI	Enter as Open	Enter as Open	Enter as Open
Horsemanship, Advanced - Pattern B	HA	Enter as Open	Enter as Open	Enter as Open
Leadline A Walk Only	ER-LAW	Enter as Open	Enter as Open	Enter as Open
Leadline A	ER-LA	Enter as Open	Enter as Open	Enter as Open
Leadline B	ER-LB	Enter as Open	Enter as Open	Enter as Open
Coached Test, Test 1 Walk Only	C-1WO	Enter as Open	Enter as Open	Enter as Open
Coached Test, Test 1	C1	Enter as Open	Enter as Open	Enter as Open
Coached Test, Test 2	C2	Enter as Open	Enter as Open	Enter as Open
Coached Test, Test 3	C3	Enter as Open	Enter as Open	Enter as Open
Physically Challenged (Test of Choice #1)	PC-TOC1	Enter as Open	Enter as Open	Enter as Open
Physically Challenged (Test of Choice #2)	PC-TOC2	Enter as Open	Enter as Open	Enter as Open

EVENTING DRESSAGE DIVISION CLASS LIST

Qualifier for the
US National Dressage Classic Regional Championships



Enter all tests of the level to be eligible for the All-Around Championship Qualifier

Description	Open	Amateur	JR
Starter	ST-O	ST-A	ST-J
Beginner Novice, Test A	BNA-O	BNA-A	BNA-J
Beginner Novice, Test B	BNB-O	BNB-A	BNB-J
Novice, Test A	NA-O	NA-A	NA-J
Novice, Test B	NB-O	NB-A	NB-J
Novice Three-Day	N3-O	N3-A	N3-J
Training, Test A	TA-O	TA-A	TA-J
Training, Test B	TB-O	TB-A	TB-J
Training Three-Day	T3D-O	T3D-A	T3D-J
Preliminary, Test A	PA-O	PA-A	PA-J
Preliminary, Test B	PB-O	PB-A	PB-J
Preliminary, Test C	PC-O	PC-A	PC-J
Preliminary Three-Day	P3-O	P3-A	P3-J
Intermediate, Test A	IntA-O	IntA-A	IntA-J
Intermediate, Test B	IntB-O	IntB-A	IntB-J
Intermediate, Test C	IntC-O	IntC-A	IntC-J
Advanced, Test A	AA-O	AA-A	AA-J
Advanced, Test B	AB-O	AB-A	AB-J
Modified, Test A	MA-O	MA-A	MA-J
Modified, Test B	MB-O	MB-A	MB-J
Modified, Test C	MC-O	MC-A	MC-J
Modified Three Day	M3-O	M3-A	M3-J

DRIVEN DRESSAGE CLASS LIST

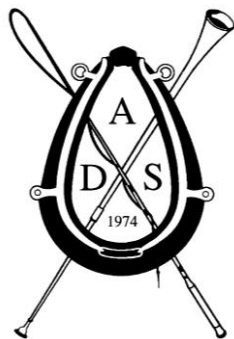

Not a member of ADS?
Join today!
[Click Here To Join](#)

ADS TRAINING LEVEL

Test	SubDivision	Class Code	Class Description
A	Single	TR-A-S	TR-A-S: Training A, Single (ADS)
A	Multiple	TR-A-M	TR-A-M: Training A, Multiple (ADS)
A	Single	ATT-A-S	ATT-A-S: AT Training A, Single (ADS)
A	Multiple	ATT-A-M	ATT-A-M: AT Training A, Multiple (ADS)
B	Single	TR-B-S	TR-B-S: Training B, Single (ADS)
B	Multiple	TR-B-M	TR-B-M: Training B, Multiple (ADS)
B	Single	ATT-B-S	ATT-B-S: AT Training B, Single (ADS)
B	Multiple	ATT-B-M	ATT-B-M: AT Training B, Multiple (ADS)
C	Single	TR-C-S	TR-C-S: Training C, Single (ADS)
C	Multiple	TR-C-M	TR-C-M: Training C, Multiple (ADS)
C	Single	ATT-C-S	ATT-C-S: AT Training C, Single (ADS)
C	Multiple	ATT-C-M	ATT-C-M: AT Training C, Multiple (ADS)
		DD (TOC)	DD (TOC): Driven Dressage Test of Choice

ADS PRELIMINARY LEVEL

Test	SubDivision	Class Code	Class Description
A	Single	PR-A-S	PR-A-S: Preliminary A, Single (ADS)
A	Multiple	PR-A-M	PR-A-M: Preliminary A, Multiple (ADS)
A	Single	ATP-A-S	ATP-A-S: AT Preliminary A, Single (ADS)
A	Multiple	ATP-A-M	ATP-A-M: AT Preliminary A, Multiple (ADS)
B	Single	PR-B-S	PR-B-S: Preliminary B, Single (ADS)
B	Multiple	PR-B-M	PR-B-M: Preliminary B, Multiple (ADS)
B	Single	ATP-B-S	ATP-B-S: AT Preliminary B, Single (ADS)
B	Multiple	ATP-B-M	ATP-B-M: AT Preliminary B, Multiple (ADS)
C	Single	PR-C-S	PR-C-S: Preliminary C, Single (ADS)
C	Multiple	PR-C-P	PR-C-P: Preliminary C, Pairs Only (ADS)
		DD (TOC)	DD (TOC): Driven Dressage Test of Choice

* Note: Preliminary C is for Singles and Pairs only

ADS INTERMEDIATE LEVEL

Test	SubDivision	Class Code	Class Description
A	Single	IN-A-S	IN-A-S: Intermediate A, Single (ADS)
A	Multiple	IN-A-M	IN-A-M: Intermediate A, Multiple (ADS)
A	Single	ATI-A-S	ATI-A-S: AT Intermediate A, Single (ADS)
A	Multiple	ATI-A-M	ATI-A-M: AT Intermediate A, Multiple (ADS)
B	Single	IN-B-S	IN-B-S: Intermediate B, Single (ADS)
B	Multiple	IN-B-M	IN-B-M: Intermediate B, Multiple (ADS)
B	Single	ATI-B-S	ATI-B-S: AT Intermediate B, Single (ADS)
B	Multiple	ATI-B-M	ATI-B-M: AT Intermediate B, Multiple (ADS)
C	Single	IN-C-S	IN-C-S: Intermediate B, Single (ADS)
C	Multiple	IN-C-M	IN-C-M: Intermediate B, Multiple (ADS)
		DD (TOC)	DD (TOC): Driven Dressage Test of Choice

ADS AT Advanced Level

Test	SubDivision	Class Code	Class Description
A	Single	AT-A-S	AT-A-S: Advanced A, Single (ADS)
A	Multiple	AT-A-M	AT-A-M: Advanced A, Multiple (ADS)

FEI Singles Only

Test	SubDivision	Class Code	Class Description
Ch P1	Single	CHP1	CHP1: Children, Pony (singles)
J and U25	Single	J-1	J-1: Junior, Pony or Horse (single)
J and U25	Singles (ponies and horses)	U25-1	U25-1: Under 25, Pony or Horse (single)
1*A	Single	1*A	1*A: Senior, Pony or Horse
1*B	Single	1*B	1*B: Senior, Pony or Horse
2* HP1	Single	2* HP1	2* HP1: Senior, Pony or Horse (single)
3* HP1	Singles (ponies and horses)	3* HP1	3* HP1: Senior, Pony or Horse (single)
PE A	Single	PE A1	PE A1: Para Single (ponies and horses)
DD (TC)	All	DD (TOC)	DD (TOC): Driven Dressage Test of Choice

Western Dressage Recognized Show

General Competition Rules



USEF rules and guidelines will be used for this show. Make sure you know and understand them. Here is a link to the Western Dressage section of the rule book. [Rule Book](#)

Minor Athlete Abuse Prevention (MAAP)

All participants must be provided with MAAP information and must be posted at the location of filming. The [poster is available](#) in this prize list and with your video sign package.

Tests

We will be using the 2022 WDAA/USEF Western Dressage tests and the 2023 Horsemanship tests. Test can be found at: www.westerndressageassociation.org

Amateur Status

If you are entering amateur classes, you must submit a WDAA DECLARATION OF AMATEUR STATUS form. Please read the form and provide needed documents accordingly. If you select option 1 (you possess an "ACTIVE" amateur card from USEF, AQHA, APHA or any other equestrian association), you must also submit a copy of the card. You may also select personal testament on the show office form.

If you are found to NOT be an amateur, you will forfeit your entries with no refund

Junior Status: Riders are eligible to compete as juniors if they are 17 years of age or less at the beginning of the 2022 competition year (December 1, 2021 – November 30, 2022).

All Decisions Are Final

All decisions of equipment checkers, show secretary, and judges are final. There is no protest covenant at this non USEF licensed event.

Class Restrictions

- NEW RULE FOR INTRODUCTORY LEVEL ELIGIBILITY: To be eligible for Intro Level, a horse/rider combination must not have shown in a Western Dressage Test at Level 1 or above in the same competition year. This rule applies to all WDAA recognized shows. The competition year is December 1, 2021 – November 30, 2022.
- Horses may be ridden by two riders. Each horse/rider combination requires a separate entry with all signatures and emergency contact. WD 102
- No horse may be ridden in the same class number more than once (even with a different rider) per WD 102.2
- Horse/rider combinations showing in walk/jog horsemanship classes are not eligible for other horsemanship classes or any test other than Introductory Level (Different horse/rider combinations are eligible for other rail classes and tests)
- Horses may only compete in levels that are adjacent with the same rider. For example, a horse may not be ridden in a basic level test and a level two test UNLESS with a different rider. WD 102.
- A horse may be ridden by a maximum of two riders. WD 102.

Therapeutic Rider Classes

Riders entered in these classes may not cross enter into other classes in the show. Participants must abide by all USEF regulations pertaining to attire, tack and equipment for the recognized show. Reference GR821 for additional information.

Attire and Equipment

USEF rules and guidelines will be used for attire and equipment. For more information please review the [USEF Western Dressage rules](#). WD 120 121 122 123.

Other

Every class offered herein which is covered by the rules and specifications of the current rules and of the current USEF/WESTERN DRESSAGE rules will be judged in accordance therewith.

This sign must be posted at all Western Dressage Filming Locations



MAAAP

MINOR ATHLETE ABUSE PREVENTION

— REQUIRED OF ALL PARTICIPANTS —

LEARN ABOUT MAAAP POLICIES

Read about these and more at
usef.org/MAAPP



SafeSport Training



One-On-One Interactions



Local Travel



Social Media and
Electronic Communications

REPORT VIOLATIONS



usef.org/safe-sport/reporting
859-225-6915



WESTERN DRESSAGE ASSOCIATION®

OF AMERICA

GUIDELINES FOR GAITED HORSES

There are a significant number of gaited horse breeds (about 30 in North America), all with gaits specific to their breed. In Western Dressage competition, the gaited horse will perform a saddle gait in place of the jog. The saddle gait selected should be the gait in which the horse is balanced and athletically comfortable performing. The saddle gait is a 4 beat lateral or diagonal gait, timely and evenly performed. The tempo, rhythm and foot falls of the gait they choose to show must not change throughout the test. The true four beat gait the horse performs, should be able to be ridden in a working, lengthened, free and collected manner as the Western Dressage test calls for.

All rules can be found in the USEF Rule Book under Western Dressage.

WD106 Saddle Gait

The saddle gait has a noticeable increase in cadence from the working walk. Excessive speed or slowness will be penalized.

1. In lieu of a jog, gaited horses perform gaits of various rhythms and footfalls. The gaited horse will perform a saddle gait in place of the jog.
2. The saddle gait may be either a lateral or diagonal gait, timely and consistently performed. The tempo, rhythm and foot falls of the gait the rider chooses to perform must not change throughout the test. The gait the horse performs, should be able to be ridden in a working, lengthened, free and collected manner as the Western Dressage test specifies.
3. The quality of the saddle gait is judged by general impression, i.e. the regularity and rhythm of the steps, the cadence and impulsion. This quality originates from the horse having a supple back and well engaged hind quarters, and the ability to maintain the same rhythm and natural balance in all variations of the saddle gait.
 - a. Collected Saddle Gait. The horse, remaining “on the bit”, moves forward with the neck raised and arched and showing clear self-carriage. The head approaches the vertical position and a light contact is maintained with the mouth. The hocks are well-engaged and must maintain an energetic gliding impulsion, enabling the shoulders to move more freely. Although the horse’s steps are shorter than in the other saddle gaits, elasticity and cadence are not lessened.
 - b. Working Saddle Gait. With an energetic, regular consistent rhythm; the horse must go forward with consistent and elastic steps. The back must be relaxed and the shoulders free, while there is an obvious push from the hindquarters. The hind legs actively glide under the horse. The horse must show proper balance and maintain light contact with the bit. The horse’s nose must be on or slightly in front of the vertical.
 - c. Lengthening of Stride. This is a variation of the Working saddle gait; the horse covers more ground while maintaining the same tempo, consistent rhythm as in the Working saddle gait. Speeding up is a fault.
 - d. Free Saddle Gait. The Free saddle gait will show moderate lengthening of stride and frame compared to the Working saddle gait. Without hurrying, the horse goes forward with clearly lengthened steps, with impulsion from the hindquarters and uphill balance. The rider allows the horse to carry the head a little more in front of the vertical than at the Collected and the Working saddle gait. The horse’s neck is “out”, down and forward, with the nose slightly in front of the vertical, with a loose rein and the poll at approximately the same height as the wither (the neck is level). The steps should be consistent, the whole movement balanced and unconstrained, while maintaining a consistent rhythm.



Western Dressage Association® of America (WDA)

P.O. Box 2349 Parker, CO 80134

www.WesternDressageAssociation.org

info@westerndressageassociation.org

FREISAN HORSE ASSOCIATION OF NORTH AMERICA



ONLINE SHOW SUBMISSIONS

Up to 2 Spotlight Horse Show tests may be submitted. Only Spotlight Horse Show results may be submitted.

PERFORMANCE AWARDS [Click this link for more information and forms](#)

Divisions included in this show are: Dressage, Western Dressage, and Driven Dressage

Dressage: All tests Introductory through FEI levels approved. Musical Freestyle approved

Western Dressage: All tests Introductory through Level 5 approved. Musical Freestyle approved

Driven Dressage: All tests

FHANA's Performance Awards are designed to reward FHANA members who are excelling in their equestrian discipline. There are nine (9) FHANA Performance Awards: Ridden Dressage, Riding, Driving, Driven Dressage, Western Dressage, In-Hand, Youth Dressage, Youth Driving, and Youth Riding. In 2019 FHANA implemented performance awards at the regional level, which allows for 7 different winners in those 9 different disciplines. Each regional winner is recognized with an award during the FHANA Annual General Meeting, and the overall winner for each discipline will be the highest scoring regional winner and become a FHANA Champion for the year. The 9 Champions will have their names placed on their discipline's perpetual trophy that is currently displayed in the FHANA office.

Please refer to the map to the [map](#) on the FHANA website to determine your FHANA region.

SPORT PREDICATE TITLES [Click this link for more information and forms](#)

The Sport predicate can be awarded to mares, gelding, and stallions that achieve good results in competitive sport. Sport can only be earned based on results achieved at shows registered with the "United States Equestrian Federation [USEF], United States Dressage Federation [USDF], Equestrian Canada, American Driving Society [ADS], Koninklijke Nederlands Hippische Sportfederatie/Royal Dutch Equestrian Federation (KNHS), and Spotlight Horse Shows [SHS]. The scores registered with USEF, USDF, ADS, Equestrian Canada, KNHS, and SHS determine qualification for the Sport predicate.

Divisions included in this show are Dressage and Driven Dressage.

Dressage: Scores must be from a test Third Level or higher

Driven Dressage: Scores must be from a single horse FEI test or any single horse Advanced ADS test with a canter movement

SPOTLIGHT HORSE SHOWS WILL PROVIDE A COPY OF YOUR VIDEO LINK TO FHANA AT THE COMPLETION OF THE SHOW. VIDEOS MAY BE UTILIZED FOR EDUCATIONAL AND PROMOTIONAL PURPOSES.



Paint Alternative Competition Program (PAC)

Description

Through the Paint Alternative Competition Program (PAC), you can get recognition for accomplishments in competitive events or just spending time in the saddle. Your accomplishments can be recorded on your registered horse's official lifetime performance record through PAC.

Easy to Enroll

An APHA or AjPHA membership is required to enroll and participate in PAC.

The horse owner must be a member to receive any awards from the association.

Annual enrollment of the horse in PAC is required, even though you don't have to own the horse.

An exhibitor's report form must be submitted within 30 days of the event or a PAC Riding Log must be submitted monthly. Forms can be found on our website at

www.apha.com/pac/forms or online submittal is available at

www.aphaonline.org/aphaonline/index.aspx.

You have 90 days to make any corrections once the PAC information is posted.

Awards

- Certificate of Recognition: A minimum of 20 credits in any one approved category
- Certificate of Achievement: 60 or more credits in any one approved category
- to the top 5 horses who earn the most
- PAC Year-End awards are presented to the top 5 horses who earn the most credits in one category along with recognition in the Paint Horse Journal.
- Six PAC Top Five awards go to the top five horses earning credits in at least six different categories in both Open and Youth categories.
- The title of Six PAC Champion will be given to any horse that places first in at least six different categories on the PAC Leader's List in a single year.
- The PAC Versatility Champion will be awarded to a horse that has earned a PAC Certificate of Achievement award in five (5) different Open PAC categories.
- The PAC Youth Versatility Champion will be awarded to a horse that has earned a PAC Certificate of Achievement award in five (5) different Youth PAC categories.

PAC Categories in this Show

Dressage – Includes Dressage, Western Dressage, and Eventing Dressage

**For more information on joining PAC, call (817) 834-2742
or e-mail pac@apha.com.**

Spotlight Horse Shows Gives Back to the Community

The Dressage Foundation

As a corporate sustaining partner for The Dressage Foundation, our monthly donations help fund this non-profit organization. Excellent grant opportunities and funding for local clinics. Full grant and clinic opportunity information are available at dressagefoundation.org.

Western Dressage Affiliates

Western Dressage affiliates who host a show receive a portion of the proceeds. They utilize these funds to support their club awards, purchase equipment, and expand on local learning opportunities.

Dressage Group Member Organizations (GMOs)

Dressage GMO's who host a show receive a portion of the proceeds. They utilize these funds to enhance the club's myriad of efforts to bring dressage to their members.

Breed Awards Spotlight Horse Shows works with breed organizations to help make breed awards available to those who show online. If you are a member of a breed organization and would like information on how online shows could work for you, please contact Gail Matheus at Gail@SpotlightHorseShows.com.

Sponsorships

If you would like to market your equestrian related company, please contact Gail Matheus at Gail@SpotlightHorseShows.com



"I have always been so very impressed with the work that The Dressage Foundation does. They make a tangible difference in the lives of their grant and scholarship recipients. It is a top-notch organization and one that we want to support."

Gail Matheus, Spotlight Horse Shows
Spotlight Horse Shows, a division of Stonegate, LLC, is a
Corporate Sustaining Partner of The Dressage Foundation.